





Thank you for purchasing this Technics product. For optimum performance and safety, please read these instructions carefully.

## Accessories

Metal wall mounts (2 pcs.)	Screws (4 pcs.)
	
Short type speaker cable (1)	Long type speaker cable (2)
	

# Connections

## Notes:

- Before connections, switch OFF the power to the amplifier.
- Use with an amplifier having 8 ohms impedance for the centre speaker and 8 ohms impedance for the rear speakers.
- Be sure to connect only positive (+) wires to positive (+) terminals, and negative (—) wires to negative (—) terminals.

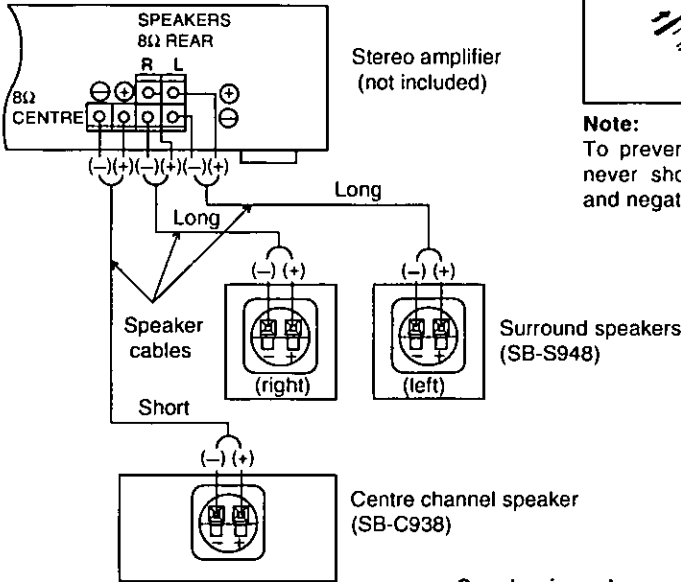

## Connection of speaker cables

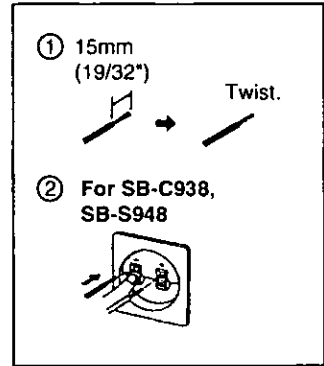

## Note:

To prevent damage to circuitry, never short circuit positive (+) and negative (—) speaker wires

## Notes

1. Be sure to reduce the volume level setting when the signal input exceeds the rated allowable input in order to avoid damage to circuitry or other malfunctions.
2. Avoid locations such as described below:
  - In direct sunlight.
  - Near heating appliances or other sources of heat.
  - Where the humidity is high.
3. Never use alcohol, paint thinner, benzine or similar chemicals to clean the unit as they may damage the finish.
4. Do not touch the diaphragms, to do so may cause distortion.

## Speaker impedance and allowed input

	Impedance	Allowed input
Centre channel speaker	8Ω	110 W (DIN)
Surround speakers	8Ω	100 W (DIN)

## Caution

The only amplifiers you should connect to your speakers are those whose output in Dolby Pro Logic does not exceed the above figures.

Using an amplifier stronger than that indicated above, you risk blowing either the amp or your speakers, moreover the possibility of fire. If equipment is damaged in any way or unexpected trouble occurs during playback, unplug the system from its outlet and call a service-man for help.

# Positioning

The diagram below shows the basic positioning of each speaker of this system.

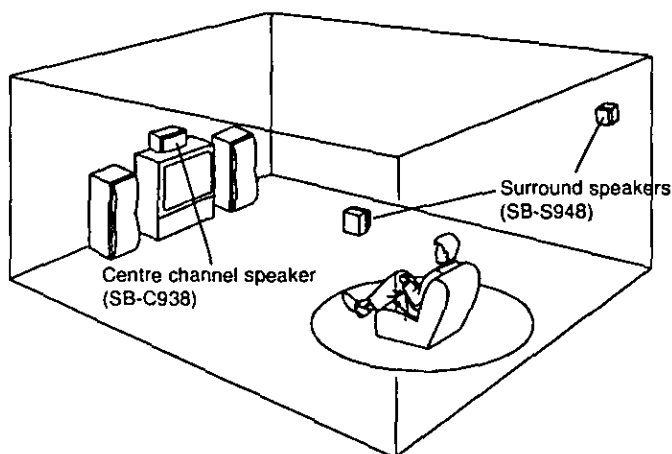

## Centre channel speaker SB-C938

Set either on top of or underneath the TV. (See overleaf for the installation procedure.)

### Note:

1. The centre channel speaker is made so as to be able to be used in close proximity to the TV but irregular colouring may result due to how the system is placed. If such a distortion occurs, turn off the TV for 15 to 30 minutes. The demagnetizing function of the TV will eliminate the distortion. If the irregular colouring is still visible, then move the speaker further away from the TV. Please note that if there is a magnetic object near the TV, irregular colouring may result due to the interaction between the TV and the speaker.

## Surround speaker (SB-S948)

Attach the speaker to the wall at a position which is at ear level and slightly behind the listening point. (See overleaf for the installation procedure.)

If the speaker cannot be attached to the wall, it can alternatively be placed on top of a shelf or on the floor.

# Wall installation

Note:

1. The wall is required to be strong enough to hold a weight of 1.6 kg (for SB-S948.)
2. The methods of installation for each speaker are the same.

## How to install the metal wall mounts

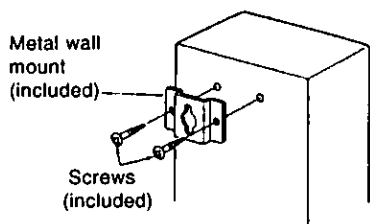

## How to install the speakers on the wall

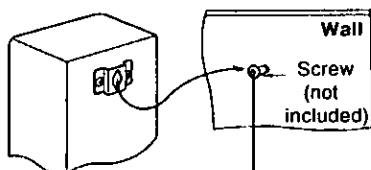

**Screw the wood screw into a thick and hard part of the wall**  
Consult your Technics dealer for details

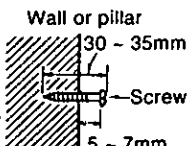

# Technical specifications

## Centre channel speaker SB-C938

Type	1-way 2 speaker system bass-reflex
Speakers	Full range: 8 cm (3-5/32") cone type
Impedance	8 ohms
Input Power	220 W, Music 110 W, (DIN)
Output Sound Pressure Level	87 dB/W (1.0 m)
Frequency Range	130 Hz - 20 KHz (-16 dB) 170 Hz - 18 KHz (-10 dB)
Dimensions (W x H x D)	320 x 130 x 100 mm 12-5/8" x 5-1/8" x 3-15/16"
Weight (approx.)	1.7 kg (3.8 lb)

## Surround speaker SB-S948

Type	1-way 2 speaker system bass-reflex
Speaker	Full range: 8 cm (3-5/32") cone type
Impedance	8 ohms
Input Power	200 W, Music 100 W, DIN
Output Sound Pressure Level	86 dB/W (1.0 m)
Frequency Range	135 Hz - 20 KHz (-16 dB) 165 Hz - 18 KHz (-10 dB)
Dimensions (W x H x D)	170 x 240 x 100 mm (6-11/16" x 9-7/16" x 3-15/16")
Weight (approx.)	1.6 kg (3.53 lb)

Note:

Specifications are subject to change without notice. Weight and dimensions are approximate.

Panasonic Consumer Electronics Company, Division of Matsushita Electric Corporation of America  
One Panasonic Way, Secaucus, New Jersey 07094  
<http://www.panasonic.com>

Panasonic Sales Company, Division of Matsushita Electric of Puerto Rico, Inc. ("PSC")  
Ave. 65 de Infantería, Km.9.5  
San Gabriel Industrial Park, Carolina, Puerto Rico 00985

Panasonic Canada Inc.  
5770 Ambler Drive, Mississauga, Ontario L4W 2T3  
[www.panasonic.ca](http://www.panasonic.ca)

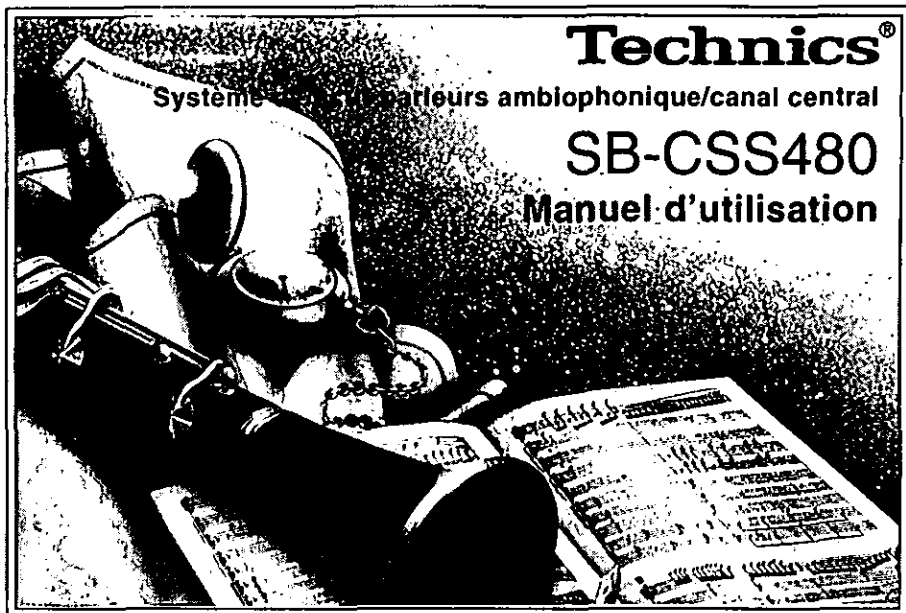

**Technics®**





Système à deux haut-parleurs ambiophonique/canal central

**SB-CSS480**

**Manuel d'utilisation**

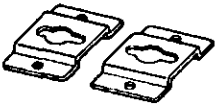
Nous vous remercions d'avoir arrêté votre choix sur ces enceintes acoustiques Technics. Pour votre sécurité, et afin d'en tirer un rendement optimal, il est recommandé de lire attentivement le présent manuel.

## Accessoires

Supports métalliques pour montage mural (2)	Vis (4)
	
Câble de raccordement type court (1)	Câbles de raccordement type longues (2)
	

# Positioning

The diagram below shows the basic positioning of each speaker of this system.

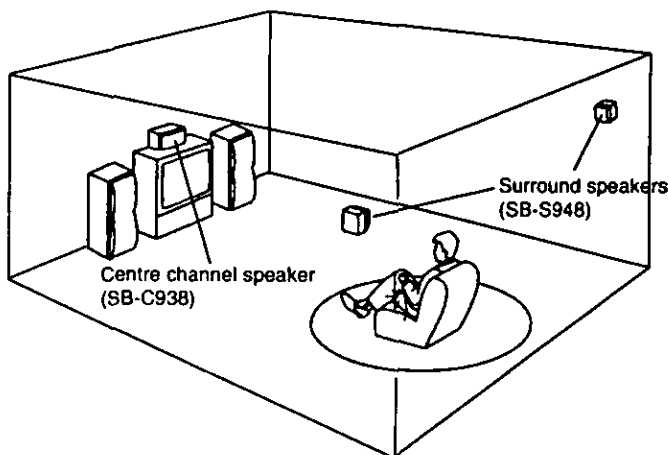

## Centre channel speaker SB-C938

Set either on top of or underneath the TV. (See overleaf for the installation procedure.)

### Note:

1. The centre channel speaker is made so as to be able to be used in close proximity to the TV but irregular colouring may result due to how the system is placed. If such a distortion occurs, turn off the TV for 15 to 30 minutes. The demagnetizing function of the TV will eliminate the distortion. If the irregular colouring is still visible, then move the speaker further away from the TV. Please note that if there is a magnetic object near the TV, irregular colouring may result due to the interaction between the TV and the speaker.

## Surround speaker (SB-S948)

Attach the speaker to the wall at a position which is at ear level and slightly behind the listening point. (See overleaf for the installation procedure.)

If the speaker cannot be attached to the wall, it can alternatively be placed on top of a shelf or on the floor.

# Emplacement

L'illustration ci-dessous indique l'emplacement de chacune des enceintes.

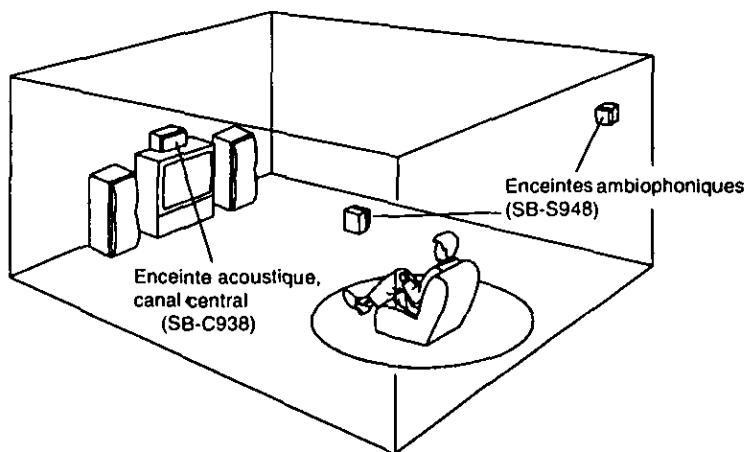

## Enceinte acoustique, canal central SB-C938

Placer sur ou sous le téléviseur. (Voir le feuillet dépliant pour la procédure d'installation.)

### Nota:

1. L'enceinte acoustique pour canal central est conçue de manière à être placée à proximité d'un téléviseur, toutefois, cela pourrait en affecter le rendu chromatique. Dans une telle éventualité, couper le contact sur le téléviseur pendant 15 à 30 minutes. La fonction de démagnétisation du téléviseur éliminera la distorsion. Si le rendu chromatique demeure anormal, éloigner l'enceinte du téléviseur.

Il est à noter qu'en présence d'un objet magnétisé près du téléviseur, la distorsion chromatique peut être causée par l'interaction entre le téléviseur et l'enceinte acoustique.

## Enceintes acoustiques ambiophoniques SB-S948

Fixer les enceintes sur un mur à la hauteur des oreilles et légèrement décalées par rapport à la position d'écoute. (Voir le feuillet dépliant pour la procédure d'installation.)

Si les enceintes ne peuvent pas être fixées à un mur, les placer sur une étagère ou encore sur le plancher.

# Installation murale

Nota:

1. La paroi murale doit pouvoir supporter un poids de 1.6 kg (SB-S948).
2. Le mode d'installation est identique pour les deux modèles d'enceintes.

## Installation avec supports métalliques

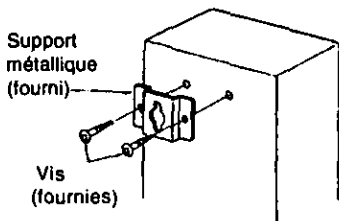

## Installation au mur

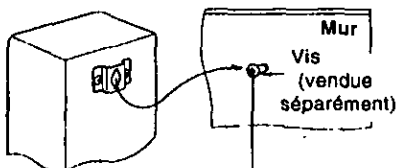

Insérer une vis à bois dans une section épaisse et résistante du mur.

Communiquer avec un détaillant Technics pour plus de détails.

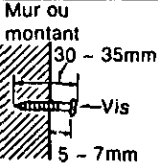

# Données techniques

## SB-C938 Enceinte pour canal central

Type	Enceinte reflex 1 voie, à deux haut-parleurs
Haut-parleurs	Pleine gamme: 8 cm (3-5/32 po) de type cône 8 ohms
Impédance	8 ohms
Puissance admissible	220W, (musicale) 110 W, DIN
Niveau de pression sonore	87 dB/W (1,0m)
Gamme de fréquence	130 Hz - 20 KHz (-16 dB) 170 Hz - 18 KHz (-10 dB)
Dimensions (L x H x P)	320 x 130 x 100mm (12-5/8 po x 5-1/8 po x 3-15/16 po)
Poids (approx.)	1,7 kg (3,8 lb)

## SB-S948 Enceinte ambiophonique

Type	Enceinte reflex 1 voie, à deux haut-parleur
Haut-parleur	Pleine gamme: 8 cm (3-5/32 po) de type cône 8 ohms
Impédance	8 ohms
Puissance admissible	200 W, (musicale) 100 W, DIN
Niveau de pression sonore	86 dB/W (1,0m)
Gamme de fréquence	135 Hz - 20 KHz (-16 dB) 165 Hz - 18 KHz (-10 dB)
Dimensions (L x H x P)	170 x 240 x 100 mm (6-11/16 po x 9-7/16 po x 3-15/16 po)
Poids (approx.)	1.6 kg (3,53 lb)

Nota:

Ces données sont susceptibles d'être changées sans préavis.